

The logo for Scharfen, featuring the word "SCHARFEN" in a bold, white, sans-serif font centered within a blue rounded rectangular background.

## **Operating Instructions for Food Slicer**

**Model ATM-3**  
**Model ATM-3 S**

**Hermann Scharfen**  
GmbH & Co. Maschinenfabrik KG

Ruhrstr. 76 - 76 a D - 58452 Witten  
Telefon 02302 – 2 82 77-13/14 Telefax 02302 - 22941

# Contents

<b>1. GENERAL INFORMATION</b>	<b>4</b>
1.1. NOTES REGARDING THE OPERATING INSTRUCTIONS	4
1.2. NOTES REGARDING WARRANTY	4
1.3. NOTES REGARDING SECURITY	4
1.4. GENERAL PLAN OF THE MACHINE	5
1.5. DIMENSIONS OF THE MACHINE AND TECHNICAL DATA	6
1.6. DESCRIPTION OF THE MACHINE	6
1.7. USAGE	7
<b>2. INSTALLATION AND INITIAL OPERATION</b>	<b>7</b>
2.1. CHECKING THE CONTENTS OF THE CARTON	7
2.2. INSTALLATION	7
2.3. ELECTRICAL INSTALLATION	8
2.4. CHECKING THE DIRECTION OF BLADE ROTATION	8
<b>3. OPERATION</b>	<b>8</b>
3.1. IMPORTANT NOTES BEFORE SWITCHING ON THE MACHINE	8
3.2. SWITCH FUNCTIONS (MAIN SWITCH WITH SIGNAL LAMP) MODEL ATM-3 AND ATM-3 S	8
3.3. THICKNESS OF SLICES	8
3.4. AUTOMATIC OR MANUAL MOVEMENT OF THE CARRIAGE	8
Adjusting automatic movement	8
3.5. OPERATION	9
3.6. SLICING OF END PIECES	9
3.7. SLICING END PIECES	10
<b>4. CLEANING</b>	<b>10</b>
4.1. HOW TO PROCEED WITH CLEANING	10
4.2. CLEANING THE SINGLE PARTS	11
4.3. CLEANING THE BLADE	11
4.4. REASSEMBLING THE PARTS	12
<b>5. SHARPENING THE BLADE</b>	<b>12</b>
5.1. SHARPENING DEVICE	13
5.2. HOW TO PROCEED FOR SHARPENING	13
5.3. SHARPENING THE BLADE	14
5.4. REMOVING THE SHARPENING DEVICE	14
<b>6. MAINTENANCE AND CLEANING</b>	<b>14</b>
<b>7. TROUBLE SHOOTING</b>	<b>15</b>
<b>8. WASTE DISPOSAL</b>	<b>15</b>



## 1. General Information

### 1.1. Notes regarding the operating instructions

Read the following hints before installing and operating this machine!

Make yourself familiar with this machine by reading this operating instructions carefully.

Within these operating instructions there are indicated the following safety notes and hints:



means Attention. Notes for probable danger and for avoiding mistakes.



means notes and hints regarding certain operation procedures.

### 1.2. Notes regarding warranty

The installation and initial operation has to be done by an authorised supplier or service technician.

Only trained persons are allowed to operate this machine. When required, the training has to be repeated.

**Supervisory and operating staff have to read the operating instructions carefully before initial operation of this machine. Starting, operating and cleaning have to be done according the operating instructions and are only allowed after having been introduced to the way of working.**

In case of

- unauthorised installation
- unauthorised electrical installation
- wrong operation
- misuse
- constructional alteration
- detaching security or protecting equipment
- and in case of using non-original Scharfen spare parts

any responsibility from our side is refused.

In above cases the operator acts on his own risk and is responsible himself for damages which might occur.



**Therefore, only use original Scharfen spare parts!**

**In case high pressure or steam cleaning devices or water plugs are used any claims regarding warranty will be refused.**

This is valid also for faults and damages which are caused by natural wear and tear.

The pictorial representation might differ from the machine supplied because of regional specific requirements or as a result of technical improvement.

The contents of these operating instructions is not affected by that.

### 1.3. Notes regarding security

This machine corresponds to legal security and hygienic requirements. Nevertheless there is a risk of getting hurt in case of wrong or inattentive operation or maintenance. Especially for your hands or fingers there is a risk of injury. The operating staff has to be trained carefully how to operate and maintain this machine according to these operating instructions.

Pay attention in any case to the following notes regarding security:



**See to it that unauthorised, untrained persons and in particular children cannot start the machine.**

**It is not allowed to detach, to modify or to disregard protecting or security equipment.**

**Otherwise there is a high risk of injury.**

Always work with concentration, do not let distract yourself from your work.

Only cut food products as indicated in these operating instructions.

Never carry out experiments. Never try to cut foreign material.

Never cut deep frozen products.

Never check the sharpness of the blade with your fingers.

Never detach the blade without suitable devices.

Never use the machine as a place to put something on or to do other work on.

Take care that the floor space is clean, dry and non-slip.

In case the current supply cable or the plug are defective, these parts have to be exchanged or repaired by your after sales service or an electrician.

For cleaning pull the plug in any case.

In case of non-typical noise switch off the machine immediately.

In case the fault cannot be put right by yourself, you have to inform your after sales service.

#### 1.4. General plan of the machine

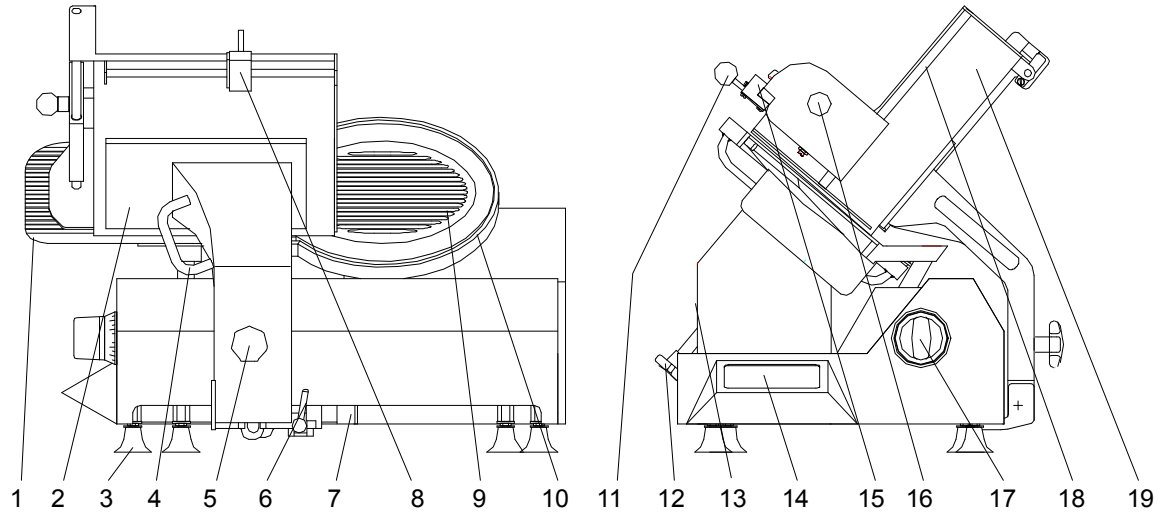

1 thickness plate

2 carriage

3 rubber foot

4 push handle

5 star knob

6 lever (automatic / manual)

7 guiding axle carriage

8 adjusting bar

9 blade guard

10 fixed ring

11 end piece holder, removable

12 star knob of fixing screw for blade guard

13 name plate

14 key board with main switch on/off (only model ATM-3 E /ATM-3 ES)  
main switch on/off (not illustrated, only model ATM-3 /ATM-3 S)

15 guiding axle for end piece holder

16 end piece holder handle

17 thickness knob

18 guiding axle

19 carriage front

### 1.5. Dimensions of the machine and technical data

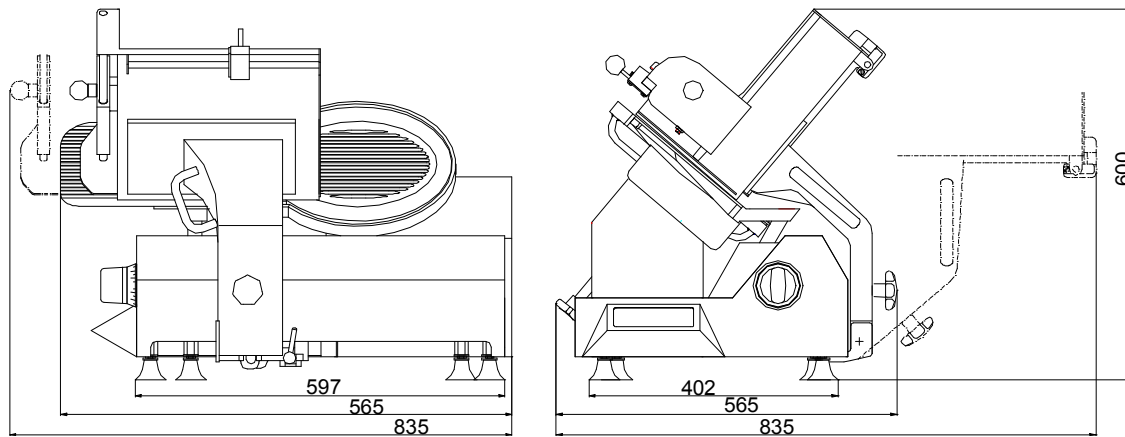

overall dimensions	728 x 565 x 600 mm	diameter of blade	300 mm (ATM-3 / ATM-3 E)
counter space required	597 x 402 mm	diameter of blade	330 mm (ATM-3 S / ATM-3 ES)
max. cutting size (blade 300 mm) app.	305 x 210 mm	sound level	< 70 db(A)
max. cutting size (blade 330 mm) app.	305 x 225 mm	weight	approximately 62 kg
thickness of slices	0 - 25 mm (infinitely variable)		
Manufacturer: Hermann Scharfen GmbH & Co. Maschinenfabrik KG Ruhrstr. 76-76a, D - 58452 Witten, Tel. 02302/2827713/14		voltage and cycles power year of production	} see rating plate

### 1.6. Description of the machine

This gravity feed slicer is a semi-automatic food slicer. The carriage is either moved backward and forward automatically or the automatic drive of the carriage can be disengaged for manual operation.

The blade is driven electrically with a 1-phase or 3-phase gear motor. This gear motor is maintenance-free and air-cooled. By means of a special air circulation the warming up of the motor is very low, especially around the blade.

The automatic carriage is moved by a strong d.c. motor.

The food product is pushed against the blade by its own weight (gravity).

The material used in the food zone corresponds to all requirements of food hygiene.

The complete machine body, the thickness plate, the blade guard and the carriage are made of stainless steel. The blade is hard chromed.

All visible bearings as well as open sliding surfaces are lubricated only with lubricant suitable for food zones.

Model ATM-3 / ATM-3 S: For switching the machine on and off there is used a double red /green push button which is illuminated when the machine is switched on.

Model ATM-3 E / ATM-3 ES: For switching the machine on and off there is used a double red/blue push button with integrated signal lamp on a key board. When the machine is switched on the signal lamps are illuminated.

The red main button fulfils the requirements as emergency stop switch.

With the other push buttons of the key board there can be adjusted different functions for the automatic operation.

Self-starting of the machine after a voltage drop is avoided by the electric control.

The carriage can only be tilted aside when the automatic drive is disengaged and the thickness plate is closed completely. When the carriage is tilted aside, the thickness plate is locked in this position.

The protecting and security equipment as well as electrical and mechanical components correspond to regulations in force.

The machine is equipped with the following security equipment:

- no self-starting of the machine after a voltage drop
- double push-button
- fixed ring around the blade, non-removable
- central blade protection, fixed, removable
- locked thickness plate when the carriage is tilted aside

### 1.7. Usage

The following food products can be sliced by taking into account the maximum cutting capacity:

- all kinds of sausages
- ham / bacon
- roast meat / cooked ham
- meat
- cheese
- bread

**The following products are not allowed to be sliced because of danger to get injured:**



- NON FOOD articles
- food products with bones
- deep frozen food products

The machine has to be installed in a shopping room. The installation in moist rooms is allowed. The room temperature must not go under the limit of 10°C and not over the limit of 40°C.

The machine is drip-proof only.

High air humidity and condensation water may damage the machine. The machine is **not splash-proof**.



For slicing cheese we recommend the tefloned execution. Carriage, thickness plate, blade guard and blade are tefloned.

For slicing bread we recommend to use a toothed blade on the machine.

The machine has to be installed in a shopping room. The installation in moist rooms is allowed. The machine is drip-proof only. High air humidity and condensation water may damage the machine. The machine is **not splash-proof**.

## 2. Installation and initial operation



- First read the operating instructions very carefully!
- You have to pay attention to all notes.
- Operating procedures have to be carried out as described.

Always work carefully and with concentration, this way you can avoid damages and injuries. The installation, introduction and initial operation has to be done by an authorised supplier or service technician.

### 2.1. Checking the contents of the carton

The supplied carton has to have the following contents:

- **SCHARFEN** food slicer model ATM-3, ATM-3 S, ATM-3 E or ATM-3 ES
- sharpening device
- these operating instructions

### 2.2. Installation



**The food slicer model ATM-3, ATM-3 S, ATM-3 E or ATM-3 ES has to be installed on a plain, horizontal, non-slip and stable surface. If necessary the machine has to be screwed tight in addition.**

Recommended height of the working surface about 800 mm. Pay attention to the required counter space.

### 2.3. Electrical installation

Before you plug in the machine, you have to check if the current supply is the same as indicated on the rating plate. In case there are discrepancies you have to inform the supplier or technical service.

#### Under no circumstances plug in the machine!

The socket-outlet has to be equipped with earthing contact. It has to be connected according to customary regulations.

A defective socket-outlet may damage the machine or endanger the operator.

The socket has to be installed at a place which can be reached easily by the operator, so that in case of emergency the plug can be pulled out quickly. **In any case the socket must not be under the counter or at a place which cannot be reached easily.**

In case it is necessary to exchange the plug, this has to be done by an electrician or the after sales service.

### 2.4. Checking the direction of blade rotation

Switch on the machine. Push the green push button.

For machines with 3-phase motor:

The blade has to rotate in direction of arrow (counter clockwise).



**In case the blade rotates in wrong direction, the positions of the poles in the plug have to be changed by an electrician or service technician.**

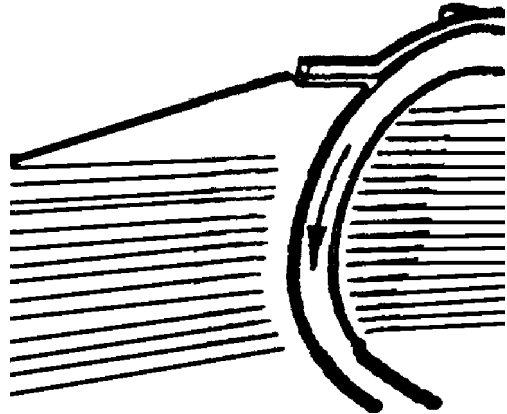

## 3. Operation

### 3.1. Important notes before switching on the machine

Because of security reasons pay attention to the following notes:



- first read these operating instructions carefully
- take care that the machine is placed on a stable and secure surface
- work with concentration
- never touch the blade

### 3.2. Switch functions (main switch with signal lamp) model ATM-3 and ATM-3 S

- green push button = main switch on
- red push button = main switch off

### 3.3. Thickness of slices

The thickness of slices is infinitely variable from 0 to 25 mm. In order to adjust the thickness of the slices you have to turn the thickness knob. Turning to the right: thickness plate opens. Turning to the left: thickness plate closes. The scale on the thickness knob serves as adjusting aid. In order to adjust a slice thickness of more than 15 mm you have to turn the thickness knob over 15 mm. For the maximum slice thickness you have to turn the thickness knob nearly two complete rotations.

### 3.4. Automatic or manual movement of the carriage

The machine is equipped with an automatic carriage movement which can be disengaged. The carriage can then be moved by hand.

automatic movement = lever in upper position

movement by hand = lever in lower position

#### Adjusting automatic movement

Switch off the machine.

Pull lever in upper position.

Move the carriage by hand until it is engaged.

Carriage can no longer be moved by hand now.

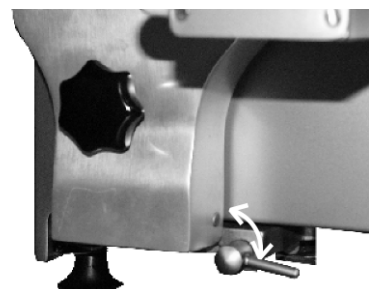



## Adjusting movement by hand

Switch off the machine

Push lever in lower position.

Carriage can be moved by hand now.

### 3.5. Operation

- Pull the carriage backwards for loading the carriage (the machine has to be in manual mode, lever in lower position).
- Pull the end piece holder upwards.
- Lay the food product against the back of the carriage.
- Adjust the adjusting bar according to the size of the food product.
- The end piece holder can be moved on the guiding bar according to the size of the food product.
- For this purpose loosen the fixing knob of the end piece holder and move it to the required position.
- Fix the screw of the end piece holder.
- Push the needles of the end piece holder into the food product.
- Adjust the thickness of the slices with the thickness knob.
- Choose automatic or manual operation (see point 3.4.).



### Manual operation

- Switch on the machine at the green or blue main switch.
- The food product is pushed against the blade by its own weight (gravity). Move the carriage backward and forward.
- After having finished the slicing procedure turn thickness knob to zero.
- Switch off the machine.



### Automatic operation

- Switch on the machine at the green or blue main switch.
- Choose electronic functions as described in chapter 3.5. (only for model ATM-3 E or ATM-3 ES)
- Push red button automatic start – stop in order to start the automatic movement (only for model ATM-3 E or ATM-3 ES)
- The food product is pushed against the blade by its own weight (gravity).
- The carriage is moved automatically
- After having finished the slicing procedure turn thickness knob to zero.
- Switch off the machine.



**Attention! Never try to load the carriage while it is moving automatically. Always switch off the machine first, otherwise there is a risk to get injured!!!**

### 3.6. Slicing of end pieces

Special notes regarding slicing of rests and end pieces of food products:

Before placing the remaining piece of the food product in the carriage you have to cut off the pointed end. Otherwise the food product cannot be held correctly by the end piece holder. It is even better to turn the original cutting side of the food product to the end piece holder.



**Attention! Risk of getting hurt!  
Never try to hold the food product by hand, you may hurt yourself seriously!  
Always use the end piece holder.**

In case the end piece should clamp or move proceed as follows:

- Switch off the machine.
- Check if the adjusting bar is fixed.
- Pull up the end piece holder
- Place the end piece into the carriage as described below in chapter 3.8.

### 3.7. Slicing end pieces

- Pull the carriage backwards for loading the carriage (the machine has to be in manual mode, lever in lower position).
- Pull the end piece holder upwards.
- Lay the food product against the back of the carriage.
- Adjust the adjusting bar according to the size of the food product.
- The end piece holder can be moved on the guiding bar according to the size of the food product.
- For this purpose loosen the fixing knob of the end piece holder and move it to the required position.
- Fix the screw of the end piece holder.
- Push the end piece holder down and place it behind the food product.
- Adjust the thickness of the slices with the thickness knob.
- Choose automatic or manual operation (see point 3.4.).

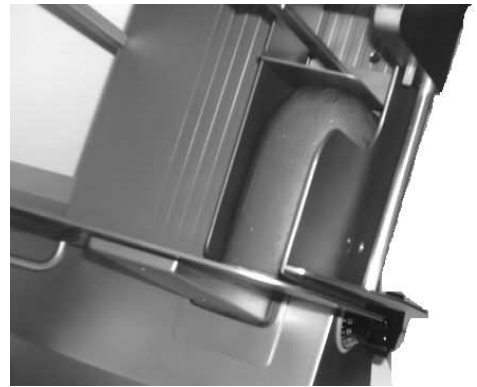

#### Manual operation

- Switch on the machine at the green or blue main switch.
- The food product is pushed against the blade by its own weight (gravity). Move the carriage backward and forward.
- After having finished the slicing procedure turn thickness knob to zero.
- Switch off the machine.



#### Automatic operation

- Switch on the machine at the green or blue main switch.
- Choose electronic functions as described in chapter 3.5. (only for model ATM-3 E or ATM-3 ES)
- Push red button automatic start – stop in order to start the automatic movement (only for model ATM-3 E or ATM-3 ES)
- The food product is pushed against the blade by its own weight (gravity).
- The carriage is moved automatically
- After having finished the slicing procedure turn thickness knob to zero.
- Switch off the machine.

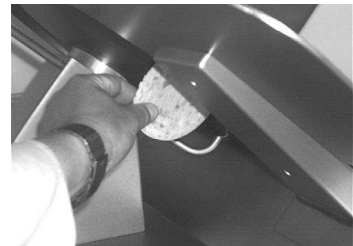

**Attention! Never try to load the carriage while it is moving automatically. Always switch off the machine first, otherwise there is a risk to get injured!!**

## 4. Cleaning

Before initial operation and after a longer period of standstill the machine has to be cleaned carefully.

With permanent use of the machine you have to clean it at least one time per day or if necessary also a few times per day. For cleaning proceed as follows:

### Risk of getting hurt!



**Be careful when cleaning the machine. Especially in the area of the knife there is a risk of injury. Always work with concentration, do not let distract yourself from your work.**

#### 4.1. How to proceed with cleaning

Switch off the machine.

Adjust manual movement of the carriage (see 3.4).

Pull off the plug.

Close the thickness plate completely by turning the thickness knob to the left.



### Taking off the end piece holders

Pull the carriage to the front.

Loosen the fixing screws of the end piece holders.

Take off both end piece holders.

### Tilting the carriage aside

Loosen the star knob of the carriage.

Pull the carriage to the utmost front position.

Tilt the carriage aside.



**The carriage cannot be tilted aside in case**

- the thickness plate is still opened
- the carriage has not been adjusted to manual movement.
- Always tilt the carriage with care, do not use force!

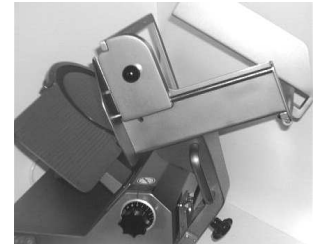

### Taking off the blade guard

- Loosen the star knob and hold the blade guard with the other hand.
- By pushing against the star knob the blade guard is tipped against your hand and you can take the blade guard off

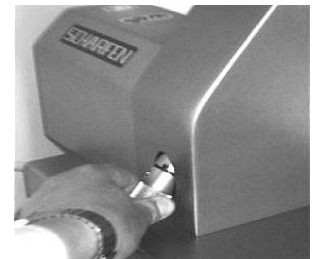

**For cleaning only use usual washing-up liquids. Do not use scratching or scouring cleansing agents or devices.**

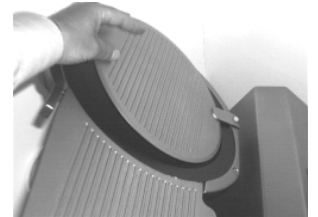

**The machine is only drip-proof. Therefore do not use high pressure cleaning devices, water hoses or similar devices. Furthermore you must not pour water over the machine. Danger of short circuit or machine defect. In such cases any claims regarding warranty will be refused.**

### 4.2. Cleaning the single parts

Clean all removed parts separately with warm water. Wash them up with clear water and dry them. **See also Chapter 6. Maintenance and Cleaning.**

### 4.3. Cleaning the blade



**Attention! Risk of getting hurt!**

Make sure that the thickness plate is closed completely and the machine is switched to manual movement (3.4)

- When the thickness plate is closed completely clean the inside of the blade with a wet cloth from the centre towards the edge.
- Proceed for the backside of the blade in the same way.
- Dry the inside and the backside of the blade carefully.

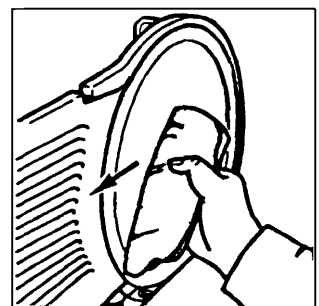

1. Put a moist cloth between the blade and the fixed protecting ring.
2. Turn the blade by hand one complete rotation and push the moist cloth against the protecting ring while turning.

1.

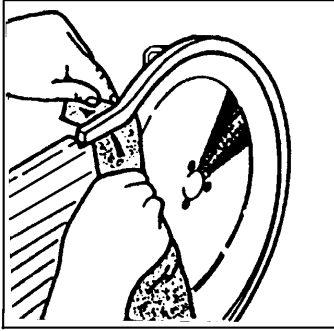

2.

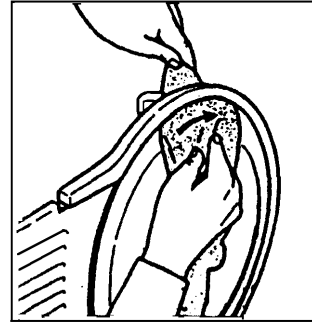

#### 4.4. Reassembling the parts

Reassemble the parts in reverse order. (4.3. -> 4.1).

##### Attention! Risk of getting hurt!

- Reassemble the parts with concentration
  - Do not let distract yourself from your work
  - Place the splice bar of the blade guard onto the plastic bolt.
  - Turn the blade guard to the blade and see to it that the flange of the blade guard is positioned in the centre of the blade.
  - Tighten the blade guard by turning the star knob clockwise by hand.
- 
- Turn the carriage back. Tighten the star knob of the carriage.
- 
- Mount the end piece holders
  - Screw tight the fixing screws of the end piece holders

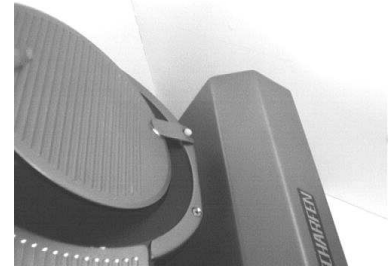

Check again the complete machine.

Only after having checked the machine plug it in for operation.

#### 5. Sharpening the blade

In case the cutting result should no longer be satisfactory or the food products are getting "beards", the blade has to be sharpened.



**Pay attention to the fact that the blade has to be exchanged if the gap between blade edge and the fixed protecting ring is more than 5 mm.**

**According to security regulations further sharpening of the blade it is not allowed when the gap is more than 5 mm.**

The supplied sharpening device is loosening its effect. A further sharpening is forbidden.

In case it is necessary to exchange the blade, see point 6.

### 5.1. Sharpening device



Every sharpening device is marked with the serial number of the machine. Only this sharpening device may be used for sharpening.

Usage of other sharpening devices can cause serious injuries or damage the machine. Never use another sharpening device.

The sharpening device is equipped with two fine sharpening stones, 1 stone for sharpening and 1 stone for taking off the burr.

Never use the sharpening device on an uncleaned machine as the stones will then lose their efficiency. In case this should happen anyway, clean the stones carefully with washing liquid and a brush.

### 5.2. How to proceed for sharpening



**Important!** Adjust the machine to manual carriage movement (see chapter 3.4.)  
Take off all removable parts (see chapter 4.1.)

**Attention! Risk of getting hurt!**

- Clean the machine carefully, as described in chapter 4.
- Turn the carriage back. Tighten the star knob of the carriage. Put a beer mat or paper felt on the carriage and cut a few strips (This way the fat will be totally removed from the blade edge)
- Check again if the machine is really turned to manual carriage movement.
- Pull the carriage completely to the front.
- Remove the beer mat or paper felt.

**Attention! Risk of getting hurt!**

- Take off both end piece holders
- Mount the sharpening device in such a way to the thickness plate that the cone of the sharpening device fits into the slit on the bottom of the thickness plate (direction of arrow)
- Pull out the pin on top of the sharpening device in direction of arrow and move the sharpening device over the edge of the thickness plate.
- Move the sharpening device with the pulled out pin to the front in direction of the blade (direction of arrow), so that the pin is engaged in the hole of the thickness plate.
- The sharpening stones are now in the correct position, i.e. the blade edge is positioned between the two sharpening stones.



### 5.3. Sharpening the blade

- Switch on the machine
- Turn the yellow handwheel of the sharpening device in direction 1. By means of this the sharpening stone sharpening the blade is pushed towards the blade.
- Approximately 15 seconds are enough.
- Switch off the machine
- check if there has been built a visible burr at the edge of the blade
- If not: Sharpen again
- Switch on the machine again
- For taking off the burr turn the yellow handwheel in direction 2. Now both sharpening stones are touching the blade.
- Approximately 2 seconds are enough to take off the burr.
- When the sharpening procedure is terminated turn the yellow handwheel to 0.

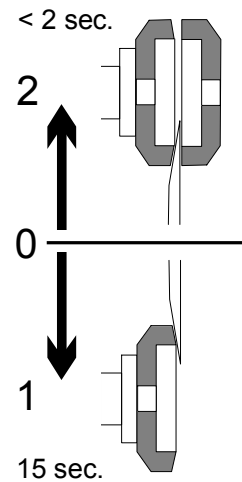

### 5.4. Removing the sharpening device

- Switch off the machine.
- Pull the pin of the sharpening device upright in direction of arrow.
- Tilt the sharpening device aside to the right.
- Remove the sharpening device.

Now clean the machine entirely from wheel swarf, see chapter 4. Cleaning. First clean the machine with a dry cloth. Then make a complete wet cleaning.



**Attention! Risk of getting hurt!**  
**Always work with concentration! Do not let distract yourself from your work!**  
**Never check the sharpness of the blade with your fingers.**

## 6. Maintenance and cleaning

**Never clean detached parts or accessories in a dish washer.**

cleaning	detergent	procedure	cleaning device	procedure after cleaning
machine	warm water, detergent, acid free from chlorine	manually	cleaning rag, cleaning brush	wash up with clear water, dry
machine with tefloned parts	warm water, detergent, acid free from chlorine	manually	cleaning rag, cleaning brush	wash up with clear water, dry <b>dry tefloned parts very carefully</b>
detached parts	warm water, detergent, acid free from chlorine	manually	cleaning rag, cleaning brush	wash up with clear water, dry
blade	warm water, detergent, acid free from chlorine	manually	cleaning rag or sponge	wash up with clear water, dry
sharpening stones	warm water, detergent, acid free from chlorine	manually	cleaning brush	degrease with degreasing agent (spirit or similar)

Clean the machine at least one time per day.

If necessary sharpen the blade.

The blade has to be exchanged if the gap between blade edge and the fixed protecting ring is more than 5 mm.

If necessary clean or exchange the sharpening stones.

For lubricating only use acid free oil.



### Oiling points:

Guiding axle of end piece holder (1 time per week)

Guiding axle of carriage (as required)

Take off the blade guard and lubricate the threaded bushing, the adapter, and the fixing screw of the blade guard (we recommend Autol Top 2000, which is used in our factory)

Lubricate the thread of the star knob for at the bottom of the carriage arm (we recommend Autol Top 2000, which is used in our factory)



### Exchanging the blade

Remove the blade guard as described in point 4.1.



#### Attention! Risk of getting hurt!

Upon request there will be supplied a knife removal device. The knife removal device has to be mounted on the blade. For this purpose put the two bolts of the knife removal device into the borings of the blade and fix the device with the star knobs.

Loosen the 4 fixing screws of the blade and take the blade off.

Take off the knife removal device and mount it on the new blade.

Mount the new blade on the machine and fasten it with the 4 fixing screws.

Take off the knife removal device and mount the blade guard.

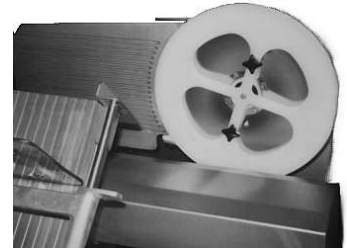

### 7. Trouble shooting

<u>Trouble</u>	<u>Solution</u>
grinding noise	blade guard has not been mounted correctly loosen blade guard, mount it again and fix it blade guard is dirty clean as described in chapter 4.
machine stops automatically	short-term voltage drop, switch on the machine again
machine is getting warm	wall socket and plug have to be checked by an electrician

### 8. Waste disposal

The producer is obliged to take back the machine for waste disposal. For this purpose the machine can be returned to the manufacturer free of charge.